

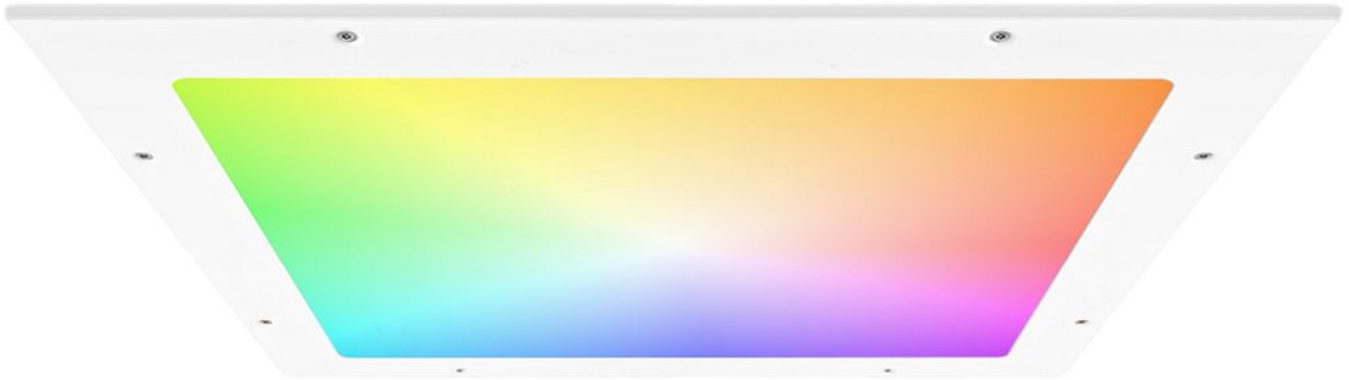

## PRODUCT SPECIFICATION

---

MOD SECURE RGBW



---

## INTRODUCTION

---

Light colour has a significant effect on mood and emotional well-being, with both psychological and physiological effects. The MOD Secure RGBW has been tested and certified to comply with the requirements of the Department of Health Environmental Design Guide, Adult Medium Secure Services, for use in secure applications where care must be taken to ensure that vulnerable patients are at minimal risk of harm. The RGBW colour changing capabilities of the MOD Secure RGBW can be used to enhance the environment and improve patient welfare.

The MOD Secure RGBW is manufactured with a robust 1.5mm steel housing and frame powder painted white, with a 6mm thick opal polycarbonate diffuser ensuring it can withstand attack from a wide range of implements without compromising the integrity of the luminaire or posing a risk to patients. When installed with anti pick mastic the MOD Secure RGBW complies with ligature resistant requirements and is also rated to IK10 and IP40.

**UK**  
**CA** CE IP40 IK10 TM21: L90>60K HOURS / L80>100K HOURS 3 STEP MACADAM ELLIPSE

---

## APPLICATION

---

- Healthcare / Social Housing

---

## SPECIFICATION

---

### CONSTRUCTION

- Housing: 1.5mm CR4 steel
- Housing: Compliant with the requirements of the Department of Health Environmental Design Guide, Adult Medium Secure Services.
- Finish: Polyester powder painted RAL 9016 textura matt white
- Diffuser: 6mm layered high transmission opal and clear polycarbonate TP(a) rated
- IK10
- IP40

### ENVIRONMENTAL

- Designed to allow simple replacement of components with commonly available tools in compliance with the Eco Design Directive, please see the installation leaflet for maintenance instructions.
- Powered by European branded drivers and emergency modules ensuring replacement parts are easily sourced.
- Every luminaire is labelled with a unique ID number allowing easy identification of spare parts for the lifetime of the product.
- Contains no single use plastics or polystyrene packaging.
- Supplied in plain card boxes with paper tape ensuring packaging is easily recycled.
- Designed to allow simple disassembly for end of life recycling.
- UK based manufacturing providing local support throughout the product lifetime and minimising transportation miles.

### CONTROL

- Optional integral Reacta-Control for integration with Reacta-Control wireless installations

### INSTALLATION

- Suitable for plasterboard installation

---

## IMAGES

---

### PRODUCT IMAGES



**TECHNICAL**

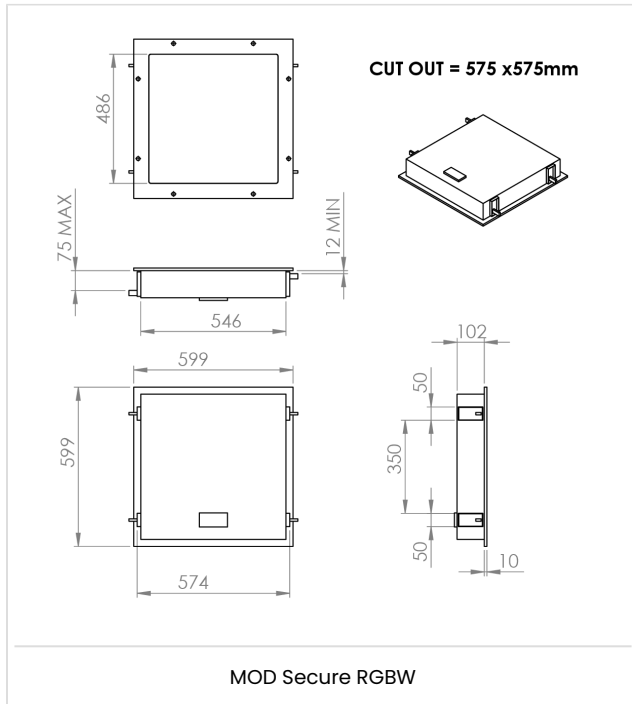

---

## WARRANTY

---

At Dextra our commitment to service has been at the forefront throughout our history spanning more than forty years in the UK lighting market. Our service ethos extends beyond design and delivery, we believe supporting your installation throughout the warranty period is equally crucial, whilst the strength and longevity of Dextra Group provides peace of mind that our warranty will be supported throughout.

The Dextra range is supplied with a five year warranty commencing from the date of delivery. During the first three years defects will be repaired on site and the warranty will include both parts and labour. For the final two years drivers, emergency modules, wireless modules, sensors and LED circuits will be supplied free of charge to replace defective components, labour and other associated costs are not included.

Certain ranges and components are subject to exemptions:

- ▶ Lithium batteries are provided with a five year warranty. During the first three years defects will be repaired on site and the warranty will include both parts and labour. For the final two years replacement batteries will be supplied free of charge to replace defective components. Five year warranty became effective as of 03/02/25, Lithium emergency luminaires supplied prior to this date are supported with a three year on site warranty only. Labour and other associated costs are not included. Nickel Metal Hydride and Nickel Cadmium batteries are provided with a one year warranty for parts and labour.
- ▶ Emergency luminaires including AME2, EXI LED, EXI3, HBE3, HBE4, OAT2 LED and Twinspace are supplied with a one year warranty for parts and labour. Lithium variants suffixed with the 5YR part code, the Autotest emergency with the LA3 part code and wireless variants with LA3RC or LSTR part codes are supplied with a five year warranty. For these extended warranty variants for the first three years defects will be repaired on site and the warranty will include both parts and labour. For the final two years replacement batteries will be supplied free of charge to replace defective components.
- ▶ Protec Micro, PTECF7 Fire Rated Downlights, Serenus and the Opus Sconce are provided with a five year replacement luminaire only warranty. Protec FR Fire Rated Downlights are provided with a 2 year replacement luminaire only warranty.
- ▶ Controls systems such as standalone sensors, switches, marshalling boxes and cabling are provided with a one year warranty for both parts and labour. DALI control systems are provided with a two year warranty for both parts and labour.
- ▶ LEDextra ranges are supplied with a three year parts or replacement luminaire only warranty with the exception of the IMPR RGBW, the Runway RGBW, the MOD RGBW, Tanek RGBW and the DexRing. These five ranges are supplied with our standard five year warranty during which defects within the first three years will be repaired on site and the warranty includes both parts and labour. For the final two years free of charge replacement components only will be supplied to rectify any failures but labour and other associated costs are not included.
- ▶ LEDEX ranges are supplied with a three year replacement luminaire only warranty.
- ▶ The Decorative Pendant ranges, Bebo, Dene, Nova, Fino and Stix are supplied with a 3 year replacement luminaire only warranty.

All warranties are subject to correct use of the product and will be invalidated by misuse, for example incorrect installation, unsuitable environmental conditions or incorrect maintenance. It is the duty of the customer to ensure that all the fault lies with the luminaire prior to requesting replacement parts or site repairs. In the event that no defect is found with the product our costs for attending site will be recharged to the customer and credit

will not be issued against returned products. No consequential losses incurred resulting from any defect with our product will be reimbursed.

Given the nature of LED technology a small percentage of LEDs may fail during the lifetime of a luminaire, this does not cause a reduction in lumen output. As such LED luminaires are only deemed to be faulty for warranty purposes when in excess of ten percent of LEDs have failed in a single luminaire.

On site repair of products under warranty will be undertaken during normal working hours, 9am to 5pm Monday to Friday, and will require unrestricted access to luminaires. Where required Dextra will provide access equipment to carry out repairs at height, should luminaires have been installed in locations where reasonable provision for maintenance access has not been made we reserve the right to supply replacement product only. On site warranty repairs will only be undertaken on the mainland of the UK and Ireland, in all other locations replacement product only will be provided.

**If you require any assistance with regards to our products please contact our Customer Services department on 01747 858100.**

## ORDER CODES

### LUMINAIRE

Code	Description	Power	Llm/W	Luminous Flux
MODSEC RGBW L45	MOD Secure, 600 x 600, 3204lIm C84, RGBW / Colour 84	31.0W	103	923lm Red, 2,380lm Green, 364lm Blue, 6,871lm RGB White

### CONTROL

Code	Description
DN	DexNET Node, Wireless Node only.
RLI	Reacta-Link, Wireless Enabled Luminaire
RC	Reacta-Control, Wireless Enabled Luminaire

## MOD Secure Installation

220-240V / 50-60Hz

IP40

IK10



**Terminal Labelling:**

<b>Power</b>	
L / 1	Switched Live
E /	Earth
N	Neutral
<b>Emergency</b>	
L2 / 2	Unswitched Live
DA/AT3	DALI Autotest
DA/AT3	DALI Autotest
<b>Dimming</b>	
-/D1/DA	Analogue/DSI/DALI
+/D2/DA	Analogue/DSI/DALI
SD	Switch Dim / Corridor Function

**WARNING:** Luminaire must be earthed. Risk of electric shock from LED boards if operated with cover removed. Installation / operation outside of luminaires intended scope invalidates warranty. Suitable only for domestic / light industrial / industrial applications within the scope of EN55015. Tested to compliance with BSEN 60598: specification for general requirements and tests. Must be installed by a suitably qualified person in accordance with all relevant legislation. Ambient operating temperature of 0°C to 25°C. If maximum operating temperature is exceeded luminaire will automatically dim / switch off. Terminal blocks are rated to 16A unless stated otherwise. The light source contained in this luminaire shall only be replaced by the manufacturer or his service agent or a similar qualified person. **LUMINAIRES WITH EMERGENCY PACK:** When supply is isolated battery output terminals may be live if battery is connected. Isolate mains and battery before servicing. Emergency luminaires require unswitched live connection taken from same phase as switched supply. When unswitched supply is connected status indicator illuminates green, when unswitched supply is disconnected indicator extinguishes and luminaire operates in emergency mode. 24 hour charge period required before undertaking full discharge test. Emergency test sheets provided should be used to record all emergency tests. Batteries should be replaced when 3 hour duration is not met. Excessive switching of permanent live may result in premature battery failure. Battery electrolyte can be harmful to eyes / open wounds, do not puncture, if electrolyte touches skin / eyes flush with water. Do not incinerate batteries.

1.

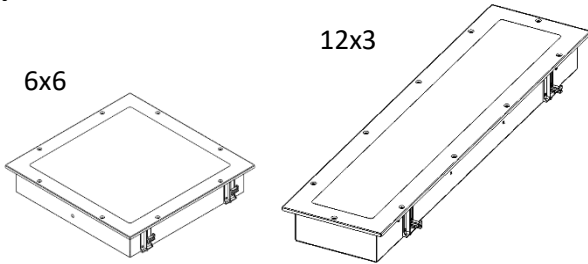

The fitting will come as a complete fitting, you will need to remove the front frame in order to install it into an appropriate ceiling.

2.

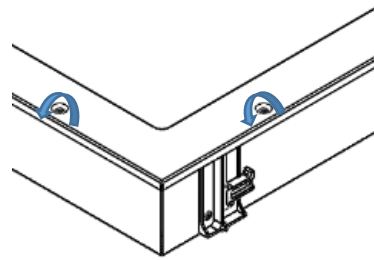

Undo the security fastener screws to release the front frame.

3.

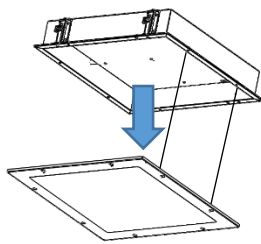

Remove the front frame from the main body of the fitting. Allow the frame to hang on the suspension wires.

4.

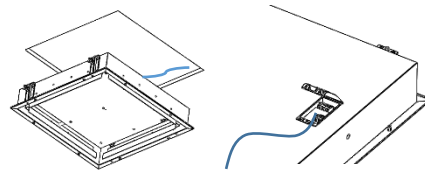

Bring the power cable down through the cut-out in the ceiling and then connect to the terminal block on the back of the fitting.

**Recommended cut-out:**

575mm x 575mm (6x6) or 1175mm x 275mm (12x3)

**Ceiling thickness:** 12-75mm

5.

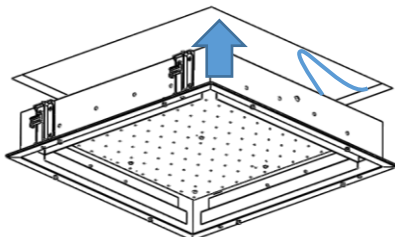

Position the fitting into the cut-out, ensuring the flag brackets are retracted.

6.

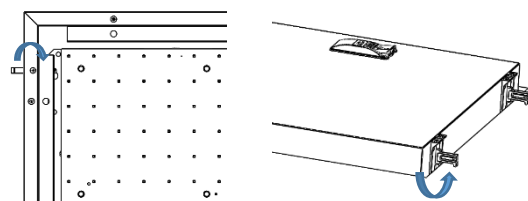

Once the fitting is in position tighten the screws to extend the flag brackets, this will pull the fitting up tight to the ceiling.

## MOD Secure Installation

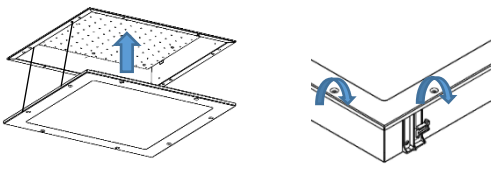
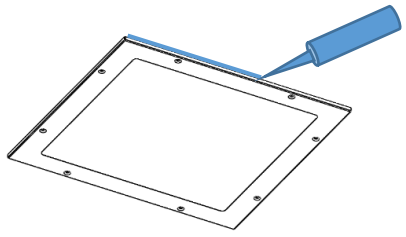
<p>7.</p>  <p>Offer the frame up to the housing and then secure in place using the 8 security fasteners that were removed previously (Step 2).</p>	<p>8.</p>  <p>Run <b>Anti-Pick Mastic</b> around the profile of the fitting ensuring a secure. Must be installed with anti-pick mastic to meet ligature resistant requirements.</p>
<p>9.</p> <p style="text-align: center;"><b><u>IF SUPPLIED IN RGBW</u></b></p> <p><b>Caution:</b></p> <p>All red, green and blue can be run at the same time, however white can only be run with one additional colour. The fitting must not run all 4 colours at the same time.</p> <p>Under no circumstances should the LEDs in this luminaire be viewed directly, only illuminate this product with the diffuser installed. Directly viewing the LEDs in this luminaire has the potential to damage eyesight.</p>	<p>10.</p> <p><b>Caution:</b></p> <p>Under no circumstances should the LEDs in this luminaire be viewed directly, only illuminate this product with the diffuser installed. Directly viewing the LEDs in this luminaire has the potential to damage eyesight.</p>
<p><u>Maintenance</u></p> <div style="display: flex; justify-content: space-between;"> <div style="width: 45%;"> <p>1 Disconnect luminaire before undertaking any maintenance or cleaning.</p> <p>2 Cleaning should be undertaken on external parts of the luminaire only using a slightly damp lint free cloth.</p> <p>3 Undo security fasteners to access fitting using a torx pin.</p> </div> <div style="width: 45%;"> <p>4 To remove gear tray from housing use a pan pozi screwdriver and remove x4 screws.</p> <p>5 Use a pan pozi screwdriver to remove components.</p> <p>6 Please contact Dextra for assistance with spare component supply.</p> </div> </div> 