



PRODUCT SPECIFICATION

ELISIAN MRI



INTRODUCTION

The Elisian MRI offers an attractive polo ring design with either opal or microprism diffusers and black or white housings. With a shallow housing the Elisian Medium is ideal for restricted void spaces whilst the construction includes no ferrous parts ensuring that it can be used in MRI scanner rooms with confidence. The Elisian is supplied with a remote driver pack for installation outside the MRI room to ensure that the drivers can not interfere with the scanner. Please note that cabling and filters to connect the remote pack to the luminaire are not included and must be supplied by the installer. The Elisian MRI is supplied in sets of 6, 8 or 10 luminaires with an appropriate driver pack to suit.



CE IP40 TM21: L90>60K HOURS / L80>100K HOURS 3 STEP MACADAM ELLIPSE

APPLICATION

- Healthcare

SPECIFICATION

CONSTRUCTION

- Housing: Injection moulded polycarbonate
- Finish: Matt black
- Finish: Matt white
- Diffuser: 2mm high transmission opal polycarbonate TP(a) rated
- Diffuser: Combined 2mm high transmission opal polycarbonate TP(a) rated and 2mm microprism anti glare PMMA
- Contains no ferrous parts, supplied with remote driver pack
- Filters and cabling to be supplied by others

PERFORMANCE

- Part L2 compliant
- BSEN 12464-1:2011 3000 Candela 65° and UGR 19 compliance
- 3SDCM Three step Macadams ellipse
- TM21: L90>60K Hours / L80>100K Hours
- Up to 130 luminaire lumens per circuit Watt.

ENVIRONMENTAL

- Designed to allow simple replacement of components with commonly available tools in compliance with the Eco Design Directive, please see the installation leaflet for maintenance instructions.
- Powered by European branded drivers and emergency modules ensuring replacement parts are easily sourced.
- Every luminaire is labelled with a unique ID number allowing easy identification of spare parts for the lifetime of the product.
- Contains no single use plastics or polystyrene packaging.
- Supplied in plain card boxes with paper tape ensuring packaging is easily recycled.
- Designed to allow simple disassembly for end of life recycling.
- UK based manufacturing providing local support throughout the product lifetime and minimising transportation miles.

INSTALLATION

- Suitable for plasterboard installation
- Suitable for mineral fibre ceiling tile installation

VARIATIONS

- Available with a wide range of colour temperatures and renderings
- Available in a range of lumen outputs

CONTROL

- Optional compatibility with a range of dimming systems including DALI and Switch Dimming

IMAGES

PRODUCT IMAGES

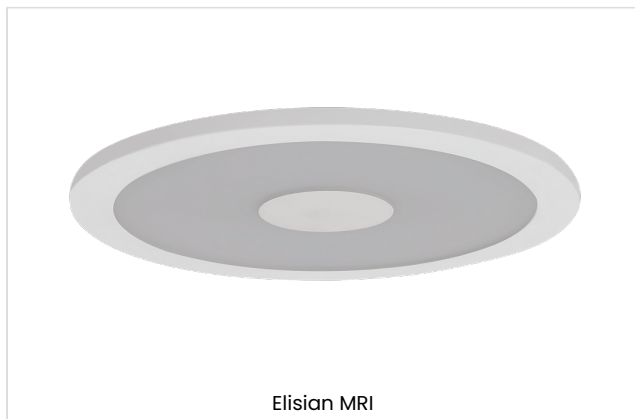

TECHNICAL

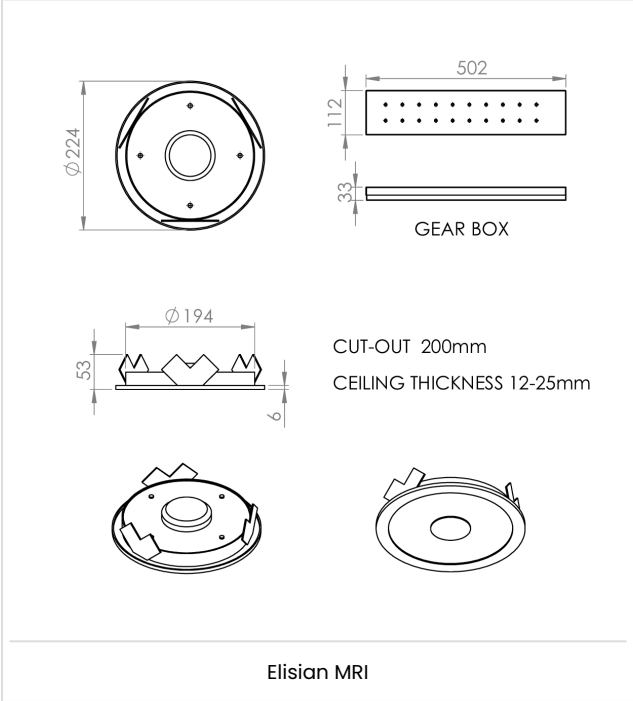

WARRANTY

At Dextra our commitment to service has been at the forefront throughout our history spanning more than forty years in the UK lighting market. Our service ethos extends beyond design and delivery, we believe supporting your installation throughout the warranty period is equally crucial, whilst the strength and longevity of Dextra Group provides peace of mind that our warranty will be supported throughout.

The Dextra range is supplied with a five year warranty commencing from the date of delivery. During the first three years defects will be repaired on site and the warranty will include both parts and labour. For the final two years drivers, emergency modules, wireless modules, sensors and LED circuits will be supplied free of charge to replace defective components, labour and other associated costs are not included.

Certain ranges and components are subject to exemptions:

- ▶ Lithium batteries are provided with a five year warranty. During the first three years defects will be repaired on site and the warranty will include both parts and labour. For the final two years replacement batteries will be supplied free of charge to replace defective components. Five year warranty became effective as of 03/02/25, Lithium emergency luminaires supplied prior to this date are supported with a three year on site warranty only. Labour and other associated costs are not included. Nickel Metal Hydride and Nickel Cadmium batteries are provided with a one year warranty for parts and labour.
- ▶ Emergency luminaires including AME2, EXI LED, EXI3, HBE3, HBE4, OAT2 LED and Twinspace are supplied with a one year warranty for parts and labour. Lithium variants suffixed with the 5YR part code, the Autotest emergency with the LA3 part code and wireless variants with LA3RC or LSTR part codes are supplied with a five year warranty. For these extended warranty variants for the first three years defects will be repaired on site and the warranty will include both parts and labour. For the final two years replacement batteries will be supplied free of charge to replace defective components.
- ▶ Protec Micro, PTECF7 Fire Rated Downlights, Serenus and the Opus Sconce are provided with a five year replacement luminaire only warranty. Protec FR Fire Rated Downlights are provided with a 2 year replacement luminaire only warranty.
- ▶ Controls systems such as standalone sensors, switches, marshalling boxes and cabling are provided with a one year warranty for both parts and labour. DALI control systems are provided with a two year warranty for both parts and labour.
- ▶ LEDextra ranges are supplied with a three year parts or replacement luminaire only warranty with the exception of the IMPR RGBW, the Runway RGBW, the MOD RGBW, Tanek RGBW and the DexRing. These five ranges are supplied with our standard five year warranty during which defects within the first three years will be repaired on site and the warranty includes both parts and labour. For the final two years free of charge replacement components only will be supplied to rectify any failures but labour and other associated costs are not included.
- ▶ LEDEX ranges are supplied with a three year replacement luminaire only warranty.
- ▶ The Decorative Pendant ranges, Bebo, Dene, Nova, Fino and Stix are supplied with a 3 year replacement luminaire only warranty.

All warranties are subject to correct use of the product and will be invalidated by misuse, for example incorrect installation, unsuitable environmental conditions or incorrect maintenance. It is the duty of the customer to ensure that all the fault lies with the luminaire prior to requesting replacement parts or site repairs. In the event that no defect is found with the product our costs for attending site will be recharged to the customer and credit

will not be issued against returned products. No consequential losses incurred resulting from any defect with our product will be reimbursed.

Given the nature of LED technology a small percentage of LEDs may fail during the lifetime of a luminaire, this does not cause a reduction in lumen output. As such LED luminaires are only deemed to be faulty for warranty purposes when in excess of ten percent of LEDs have failed in a single luminaire.

On site repair of products under warranty will be undertaken during normal working hours, 9am to 5pm Monday to Friday, and will require unrestricted access to luminaires. Where required Dextra will provide access equipment to carry out repairs at height, should luminaires have been installed in locations where reasonable provision for maintenance access has not been made we reserve the right to supply replacement product only. On site warranty repairs will only be undertaken on the mainland of the UK and Ireland, in all other locations replacement product only will be provided.

If you require any assistance with regards to our products please contact our Customer Services department on 01747 858100.

ORDER CODES

LUMINAIRE

Code	Description	Power	Llm/W
ELNM MRI L11 X6 **	Elisian Medium MRI, 915lIm, Colour 84, 6 Pack	7.5W	122
ELNM MRI L11 X8 **	Elisian Medium MRI, 915lIm, Colour 84, 8 Pack	7.5W	122
ELNM MRI L11 X10 **	Elisian Medium MRI, 915lIm, Colour 84, 10 Pack	7.5W	122
ELNM MRI L20 X6 **	Elisian Medium MRI, 1,664lIm, Colour 84, 6 pack	12.8W	130
ELNM MRI L20 X8 **	Elisian Medium MRI, 1,664lIm, Colour 84, 8 pack	12.8W	130
ELNM MRI L20 X10 **	Elisian Medium MRI, 1,664lIm, Colour 84, 10 pack	12.8W	130

Luminaire lumen values are based on Opal diffuser

COLOUR

Code	Description
WH	White
BL	Black

OPTIC

Code	Description
OP	Opal Diffuser
MP	Microprism Diffuser

DIMMING

Code	Description
A	DALI Digital Addressable Lighting Interface
S	Switch Dimming

MISCELLANEOUS

Code	Description
C**	Select Colour Temperature and Rendering: C827, C83, C85, C865, C93, C94
LSF	Low Smoke Zero Halogen

220-240V / 50-60Hz
IP20 IK**

Terminal Labelling:

Power

L1 Switched Live
E Earth
N Neutral

Emergency

L2 Unswitched Live
DA/AT3 DALI Autotest

Dimming

-/D1/DA Analogue/DSI/DALI
+/D2/DA Analogue/DSI/DALI
L3 Switch Dim / Corridor Funct



WARNING: Luminaire must be earthed. Risk of electric shock from LED boards if operated with cover removed. Installation / operation outside of luminaires intended scope invalidates warranty. Suitable only for domestic / light industrial / industrial applications within the scope of EN55015. Tested to compliance with BSEN 60598: specification for general requirements and tests. Must be installed by a suitably qualified person in accordance with all relevant legislation. Ambient operating temperature of 0°C to 25°C. If maximum operating temperature is exceeded luminaire will automatically dim / switch off. Terminal blocks are rated to 16A unless stated otherwise. The light source contained in this luminaire shall only be replaced by the manufacturer or his service agent or a similar qualified person. **LUMINAIRES WITH EMERGENCY PACK:** When supply is isolated battery output terminals may be live if battery is connected. Isolate mains and battery before servicing. Emergency luminaires require unswitched live connection taken from same phase as switched supply. When unswitched supply is connected status indicator illuminates green, when unswitched supply is disconnected indicator extinguishes and luminaire operates in emergency mode. 24 hour charge period required before undertaking full discharge test. Emergency test sheets provided should be used to record all emergency tests. Batteries should be replaced when 3 hour duration is not met. Excessive switching of permanent live may result in premature battery failure. Battery electrolyte can be harmful to eyes / open wounds, do not puncture, if electrolyte touches skin / eyes flush with water. Do not incinerate batteries.

1.

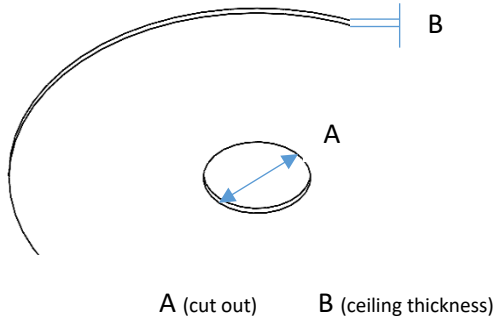

ELN M - MRI	200mm	12-25mm
-------------	-------	---------

2.

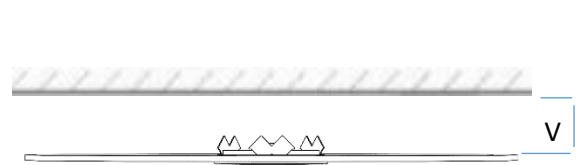

Min void 'V'

ELN M - MRI	60mm
-------------	------

3.

Insert loop in/out box first

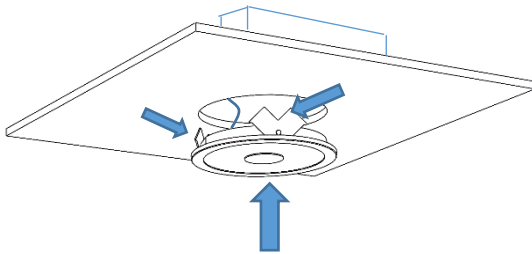

Flex plastic wings into cut-out then push luminaire up until luminaire is secure

4.

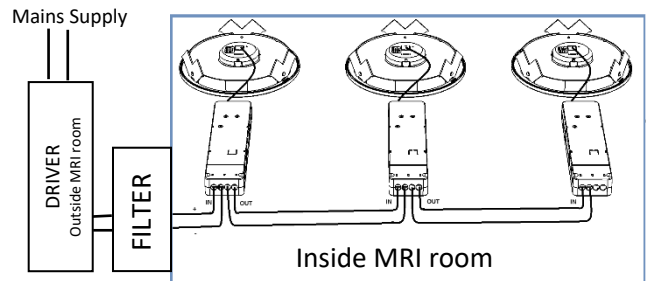

Driver must be located outside the MRI room and the Filter is to be supplied by others

5.

Driver Gearbox

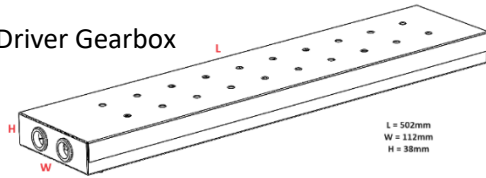

Loop in / Loop out box

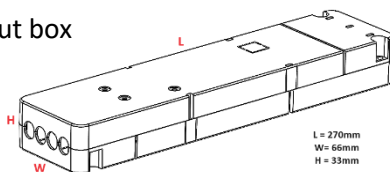

6.

Wiring Configuration

Luminaires	Drivers	Wired
6	2	3 Luminaires / Driver
8	2	4 Luminaires / Driver
10	2	5 Luminaires / Driver

(Flex to be supplied by contractor)

Recommended flex lengths

Flex Length	Core Size
0-15M	0.5mm ²
>15M	0.75mm ²