



## PRODUCT SPECIFICATION

---

AMENITY PLUS METAL – SQUARE



## INTRODUCTION

The Amenity Plus Metal Square is available in lumen outputs ranging from 1500 to 3000 and is manufactured with a high pressure die cast aluminium housing with an injection moulded polycarbonate diffuser for improved strength and durability and can be offered with a range of dimming types, integral lithium emergency and black or white housings.

The Amenity Plus range includes premium mid power LEDs offering excellent efficiency and longevity with a lifetime of L90 at 60,000 operating hours. Energy savings can be further enhanced with a selection of integral presence detection and bright out microwave sensors including on / off, bi level dimming and wireless variants allowing luminaires to be grouped for simultaneous operation.

The Amenity Plus range is sealed to IP65 allowing for use in external areas such as under canopies or wall mounting, however is equally suited to a range of internal applications such as corridors, stairways, toilets and storage areas.

**UK**  
**CA** CE IP65 IK10 TM21: L90>60K HOURS / L80>100K HOURS 3 STEP MACADAM ELLIPSE

---

## APPLICATION

---

- Canteen
- Commercial / Offices
- Corridor
- Education
- Exterior
- Healthcare / Social Housing
- Hotel / Leisure
- Industrial / Manufacturing
- Parking / Exterior
- Retail
- Stairwell
- Store Room
- Toilet
- Transport
- Warehousing

---

## SPECIFICATION

---

### CONSTRUCTION

- Housing: High pressure die cast aluminium
- Finish: Matt black
- Finish: Matt white
- Diffuser: Injection moulded high transmission opal polycarbonate
- IK10
- IP65

### PERFORMANCE

- Part L2 compliant
- 3SDCM Three step Macadams ellipse
- TM21: L90>60K Hours / L80>100K Hours
- Up to 94 luminaire lumens per circuit Watt.

### ENVIRONMENTAL

- Designed to allow simple replacement of components with commonly available tools in compliance with the Eco Design Directive, please see the installation leaflet for maintenance instructions.
- All critical components are mounted on a single tray for simple end of life repair or upgrade.
- Powered by European branded drivers and emergency modules ensuring replacement parts are easily

sourced.

- Every luminaire is labelled with a unique ID number allowing easy identification of spare parts for the lifetime of the product.
- Contains no single use plastics or polystyrene packaging.
- Supplied in plain card boxes with paper tape ensuring packaging is easily recycled.
- Designed to allow simple disassembly for end of life recycling.
- UK based manufacturing providing local support throughout the product lifetime and minimising transportation miles.

### EMERGENCY

- Available with optional standard, self test and autotest integral emergency with lithium batteries for extended warranty and lifetime.
- Optional Reacta-Link wireless emergency for automated centralised reporting.
- Optional Reacta-Control wireless emergency for automated centralised reporting.

### CONTROL

- Optional compatibility with a range of dimming systems including DALI, DSI and Switch Dimming
- Optional Integral R25 microwave presence and bright out sensor
- Optional integral Reacta-Link for integration with Reacta-Link wireless installations
- Optional integral Reacta-Control for integration with Reacta-Control wireless installations
- Optional integral photocell

### INSTALLATION

- Suitable for conduit installation
- Suitable for surface installation
- Retrofit in existing luminaires

### VARIATIONS

- Available with a wide range of colour temperatures and renderings
- Available in a range of lumen outputs
- Available in white or black finishes
- Available with optional night light

## IMAGES

### PRODUCT IMAGES



## PROJECT IMAGES



The Sycamores using the Amenity Plus Metal - Square

TECHNICAL

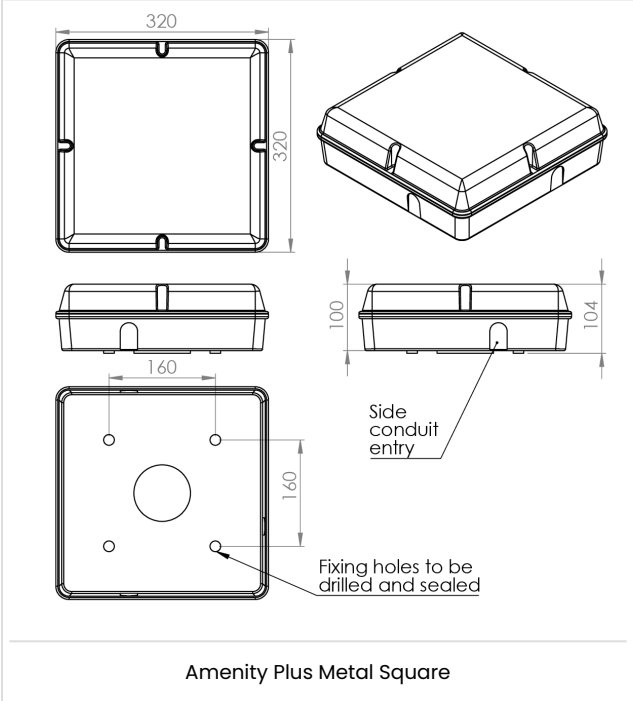

---

## WARRANTY

---

At Dextra our commitment to service has been at the forefront throughout our history spanning more than forty years in the UK lighting market. Our service ethos extends beyond design and delivery, we believe supporting your installation throughout the warranty period is equally crucial, whilst the strength and longevity of Dextra Group provides peace of mind that our warranty will be supported throughout.

The Dextra range is supplied with a five year warranty commencing from the date of delivery. During the first three years defects will be repaired on site and the warranty will include both parts and labour. For the final two years drivers, emergency modules, wireless modules, sensors and LED circuits will be supplied free of charge to replace defective components, labour and other associated costs are not included.

Certain ranges and components are subject to exemptions:

- ▶ Lithium batteries are provided with a five year warranty. During the first three years defects will be repaired on site and the warranty will include both parts and labour. For the final two years replacement batteries will be supplied free of charge to replace defective components. Five year warranty became effective as of 03/02/25, Lithium emergency luminaires supplied prior to this date are supported with a three year on site warranty only. Labour and other associated costs are not included. Nickel Metal Hydride and Nickel Cadmium batteries are provided with a one year warranty for parts and labour.
- ▶ Emergency luminaires including AME2, EXI LED, EXI3, HBE3, HBE4, OAT2 LED and Twinspot are supplied with a one year warranty for parts and labour. Lithium variants suffixed with the 5YR part code, the Autotest emergency with the LA3 part code and wireless variants with LA3RC or LSTR part codes are supplied with a five year warranty. For these extended warranty variants for the first three years defects will be repaired on site and the warranty will include both parts and labour. For the final two years replacement batteries will be supplied free of charge to replace defective components.
- ▶ Protec Micro, PTECF7 Fire Rated Downlights, Serenus and the Opus Sconce are provided with a five year replacement luminaire only warranty. Protec FR Fire Rated Downlights are provided with a 2 year replacement luminaire only warranty.
- ▶ Controls systems such as standalone sensors, switches, marshalling boxes and cabling are provided with a one year warranty for both parts and labour. DALI control systems are provided with a two year warranty for both parts and labour.
- ▶ LEDextra ranges are supplied with a three year parts or replacement luminaire only warranty with the exception of the IMPR RGBW, the Runway RBGW, the MOD RGBW, Tanek RGBW and the DexRing. These five ranges are supplied with our standard five year warranty during which defects within the first three years will be repaired on site and the warranty includes both parts and labour. For the final two years free of charge replacement components only will be supplied to rectify any failures but labour and other associated costs are not included.
- ▶ LEDEX ranges are supplied with a three year replacement luminaire only warranty.
- ▶ The Decorative Pendant ranges, Bebo, Dene, Nova, Fino and Stix are supplied with a 3 year replacement luminaire only warranty.

All warranties are subject to correct use of the product and will be invalidated by misuse, for example incorrect installation, unsuitable environmental conditions or incorrect maintenance. It is the duty of the customer to ensure that all the fault lies with the luminaire prior to requesting replacement parts or site repairs. In the event that no defect is found with the product our costs for attending site will be recharged to the customer and credit

will not be issued against returned products. No consequential losses incurred resulting from any defect with our product will be reimbursed.

Given the nature of LED technology a small percentage of LEDs may fail during the lifetime of a luminaire, this does not cause a reduction in lumen output. As such LED luminaires are only deemed to be faulty for warranty purposes when in excess of ten percent of LEDs have failed in a single luminaire.

On site repair of products under warranty will be undertaken during normal working hours, 9am to 5pm Monday to Friday, and will require unrestricted access to luminaires. Where required Dextra will provide access equipment to carry out repairs at height, should luminaires have been installed in locations where reasonable provision for maintenance access has not been made we reserve the right to supply replacement product only. On site warranty repairs will only be undertaken on the mainland of the UK and Ireland, in all other locations replacement product only will be provided.

**If you require any assistance with regards to our products please contact our Customer Services department on 01747 858100.**

## ORDER CODES

### LUMINAIRE

#### Large Square Metal

Code	Description	Power	Llm/W
AMES L15 BO MET	Amenity Plus, 898llm, Large Square Metal, Black Opal, Colour 84	9.5W	94
AMES L15 WO MET	Amenity Plus, 898llm, Large Square Metal, White Opal, Colour 84	9.5W	94
AMES L20 BO MET	Amenity Plus, 1,187llm, Large Square Metal, Black Opal, Colour 84	14.6W	81
AMES L20 WO MET	Amenity Plus, 1,187llm, Large Square Metal, White Opal, Colour 84	14.6W	81
AMES L30 BO MET	Amenity Plus, 1,794llm, Large Square Metal, Black Opal, Colour 84	22.3W	80
AMES L30 WO MET	Amenity Plus, 1,794llm, Large Square Metal, White Opal, Colour 84	22.3W	80

### DIMMING

Code	Description
A	DALI Digital Addressable Lighting Interface
S	Switch Dimming
D	DSI Digital Dimming
C	Bi-Level Dimming For Standalone Switched Sensor

### CONTROL

Code	Description
DN	DexNET Node, Wireless Node only.
R25E	Reacta 25, Presence & Bright Out, On / Off, 2.5-4M
R25C*	Reacta 25, Presence & Bright Out, Bi-Level Dimming, 2.5-4M
PH	Photocell
RLM	Reacta-Link, Wireless, Presence & Bright Out, 2.5-4M
RC	Reacta-Control, Wireless Enabled Luminaire
RCMC*	Reacta-Control, Presence & Bright Out, Bi-level Dimming, 2.5-4M
RCME	Reacta-Control, Presence & Bright Out, On / Off, 2.5-4M

Please click [here](#) for full details on our wireless controls.

\*Bi-Level Dimming will only dim the luminaire to 10% during absence and brightout, it will not turn the luminaire off.

### EMERGENCY

Code	Description
LE3	Lithium Standard Emergency 3 Hour
LS3	Lithium Selftest Emergency 3 Hour
LA3	Lithium Autotest Emergency 3 Hour
LA3D	Lithium DexNET Emergency 3 Hour
LSTR	Lithium Reacta-Link Emergency 3 Hour
LA3RC	Lithium Reacta-Control Emergency 3 Hour
CB	Central Battery, Please Specify 110V or 230V when Ordering

### MISCELLANEOUS

Code	Description
C**	Select Colour Temperature and Rendering; C827, C83, C85, C865, C93, C94
NL	Night Light (Non Emergency Variants Only)
TRS	Tamper Resistant Screws
TRS INSTALL KIT	Tamper Resistant Compatible Screwdriver Heads
LSF	Low Smoke Zero Halogen

220-240V / 50-60Hz  
IP65

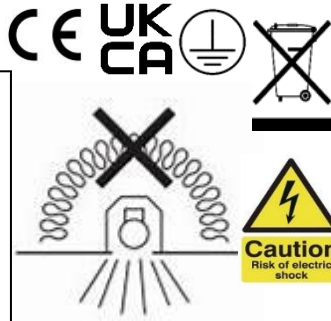

**WARNING:** Luminaire must be earthed. Risk of electric shock from LED boards if operated with cover removed. Installation / operation outside of luminaires intended scope invalidates warranty. Suitable only for domestic / light industrial / industrial applications within the scope of EN55015. Tested to compliance with BSEN 60598: specification for general requirements and tests. Must be installed by a suitably qualified person in accordance with all relevant legislation. Ambient operating temperature of 0°C to 25°C. If maximum operating temperature is exceeded luminaire will automatically dim / switch off. Terminal blocks are rated to 16A unless stated otherwise. The light source contained in this luminaire shall only be replaced by the manufacturer or his service agent or a similar qualified person. **LUMINAIRES WITH EMERGENCY PACK:** When supply is isolated battery output terminals may be live if battery is connected. Isolate mains and battery before servicing. Emergency luminaires require unswitched live connection taken from same phase as switched supply. When unswitched supply is connected status indicator illuminates green, when unswitched supply is disconnected indicator extinguishes and luminaire operates in emergency mode. 24 hour charge period required before undertaking full discharge test. Emergency test sheets provided should be used to record all emergency tests. Batteries should be replaced when 3 hour duration is not met. Excessive switching of permanent live may result in premature battery failure. Battery electrolyte can be harmful to eyes / open wounds, do not puncture, if electrolyte touches skin / eyes flush with water. Do not incinerate batteries.

Terminal Labelling:	
<b>Power</b>	
L1	Switched Live
E	Earth
N	Neutral
<b>Emergency</b>	
L2	Unswitched Live
DA/AT3	DALI Autotest
DA/AT3	DALI Autotest
<b>Dimming</b>	
-D1/DA	Analogue/DSI/DALI
+D2/DA	Analogue/DSI/DALI
L3	Switch Dim / Corridor Function

<p><b>1.</b></p> <p>To remove the diffuser, either directly pull off (for snap-on diffuser) or remove screws to release the diffuser.</p>	<p><b>2.</b></p> <p>Release gear tray from the main housing. This is usually done by removing screws or releasing spring clips.</p> <p>If gear tray is hinged, swing out to the 3 o'clock position.</p> <p>If fluorescent, remove lamp and gear tray if applicable.</p>
<p><b>3.</b></p> <p>Drill a suitably sized hole in one of the designated places on the housing. The central Besa can be used as a cable entry if required.</p>	<p><b>4.</b></p> <p>Attach the housing to the designated wall or ceiling with appropriate screws. Use the holes marked in housing.</p> <p>If the gear tray is hinged, mount on wall with hinge at 3 o'clock position.</p> <p><b>NOTE: If IP65 rated, failure to seal these holes will invalidate the warranty.</b></p>
<p><b>5.</b></p> <p>Feed mains cable through the recently drilled hole. Use IP65 gland if necessary.</p> <p><b>NOTE: It is the contractor's responsibility to ensure the cable has been sealed in the drilled hole to retain its IP65 rating. Failure to do so will invalidate the warranty.</b></p>	<p><b>6.</b></p> <p>Wire the mains cable to the respective terminals on terminal block. Test the luminaire before reattaching the diffuser.</p> <p>Reverse steps 1 and 2 to reattach the gear tray and diffuser. Fit any decorative attachments after replacing diffuser.</p>

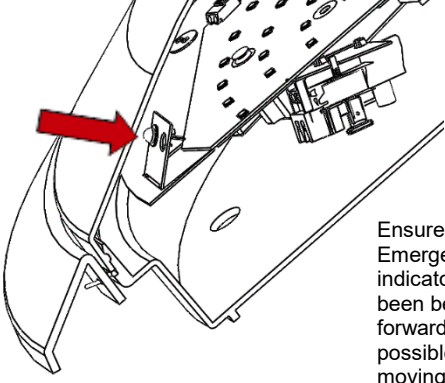
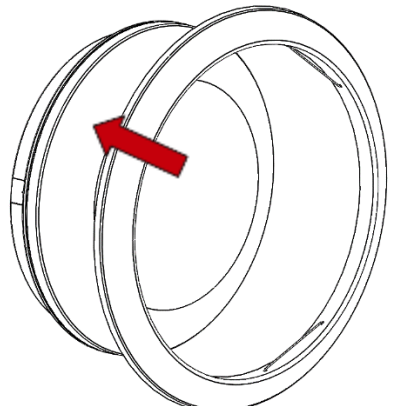
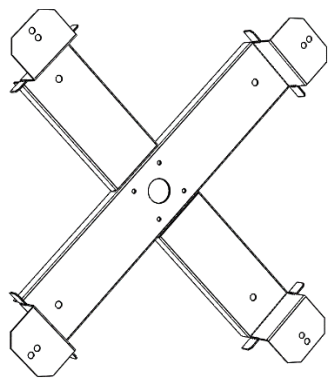
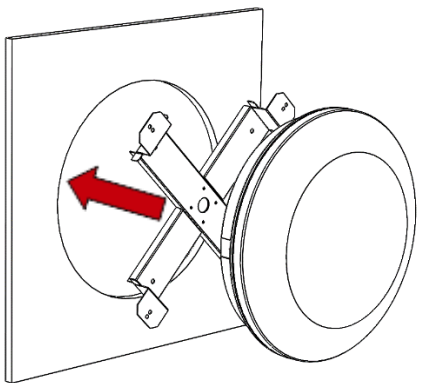
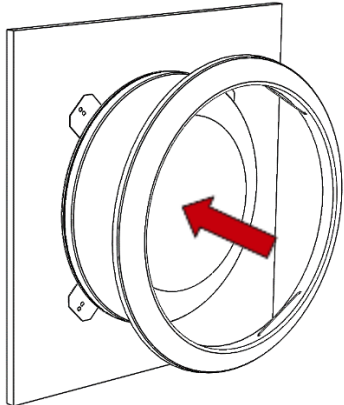
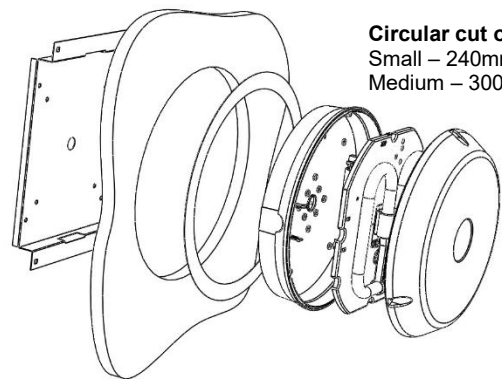
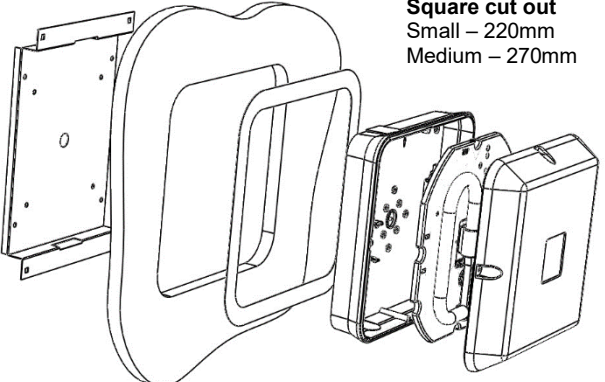
<p>7.</p>  <p>Ensure the Emergency LED indicator tab has been bent as far forward as possible before moving on to the next luminaire.</p>	<p>8.</p> <p><b>AMED Decorative Ring</b></p>  <p>Fit the optional decorative trim by engaging 3No. Springs into the recess between diffuser and base.</p>
<p>9. <b>Semi-recessing kit for AMED</b></p>  <p>330mm diameter cut out required for AMED.</p> <p>Ensure the tabs are positioned as shown on the brackets before installing.</p>	<p>10.</p>  <p>Secure semi-recessing kit into the wall/ ceiling aperture. Bend the tabs back to lock it securely into place.</p> <p>The luminaire can then be attached to the kit using the 4no. Screws.</p>
<p>11.</p>  <p>An angled decorative ring must be fitted when using the semi-recessing kit.</p>	<p>12. <b>Semi-recessing kit for AMC/ AMS</b></p>  <p><b>Circular cut out</b> Small – 240mm Dia Medium – 300mm Dia</p>
<p>13.</p>  <p><b>Square cut out</b> Small – 220mm Medium – 270mm</p>	<p>14.</p>

## Maintenance

- 1 Disconnect luminaire before undertaking any maintenance or cleaning.
- 2 Cleaning should be undertaken on external parts of the luminaire only using a slightly damp lint free cloth.
- 3 To remove diffuser directly pull off to release.
- 4 Push tab back to release gear tray.
- 5 Use a pan pozi screwdriver to remove components.
- 6 Please contact Dextra for assistance with spare component supply.

