

Rubix 1 Installation

220-240V / 50-60Hz
IP20

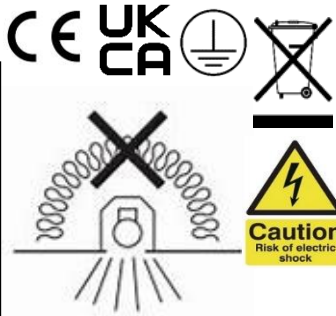

WARNING: Luminaire must be earthed. Risk of electric shock from LED boards if operated with cover removed. Installation / operation outside of luminaires intended scope invalidates warranty. Suitable only for domestic / light industrial / industrial applications within the scope of EN55015. Tested to compliance with BSEN 60598: specification for general requirements and tests. Must be installed by a suitably qualified person in accordance with all relevant legislation. Ambient operating temperature of 0°C to 25°C. If maximum operating temperature is exceeded luminaire will automatically dim / switch off. Terminal blocks are rated to 16A unless stated otherwise. The light source contained in this luminaire shall only be replaced by the manufacturer or his service agent or a similar qualified person. **LUMINAIRES WITH EMERGENCY PACK:** When supply is isolated battery output terminals may be live if battery is connected. Isolate mains and battery before servicing. Emergency luminaires require unswitched live connection taken from same phase as switched supply. When unswitched supply is connected status indicator illuminates green, when unswitched supply is disconnected indicator extinguishes and luminaire operates in emergency mode. 24 hour charge period required before undertaking full discharge test. Emergency test sheets provided should be used to record all emergency tests. Batteries should be replaced when 3 hour duration is not met. Excessive switching of permanent live may result in premature battery failure. Battery electrolyte can be harmful to eyes / open wounds, do not puncture, if electrolyte touches skin / eyes flush with water. Do not incinerate batteries.

Terminal Labelling:	
Power	
L / 1	Switched Live
E / ⊕	Earth
N	Neutral
Emergency	
L2 / 2	Unswitched Live
DA/AT3	DALI Autotest
DA/AT3	DALI Autotest
Dimming	
-/D1/DA	Analogue/DSI/DALI
+/D2/DA	Analogue/DSI/DALI
SD	Switch Dim / Corridor Function

1.

Unpack luminaire
(note – luminaire is complete and ready to install)

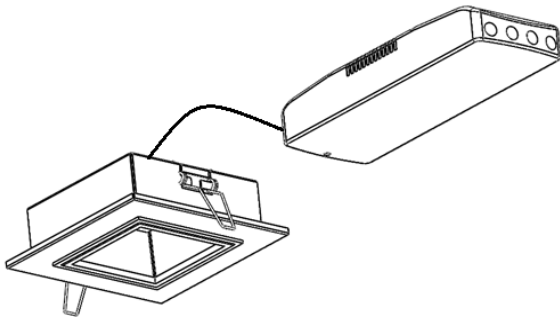

2.

Cut a **115mm x 115mm** cutout in the centre of the selected tile. Feed the mains cable to the cutout, so it is ready to be connected to the driver.

Tile thickness
5mm (min)
20mm (max)

Ceiling Void Depth
70mm (min)

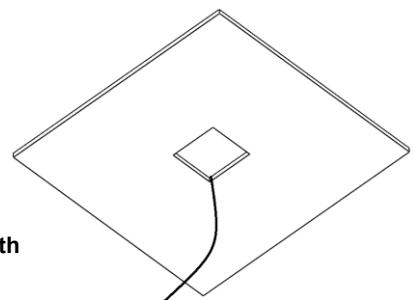

3.

Feed mains cable into the independent driver. Ensure the cable is restrained inside the driver.

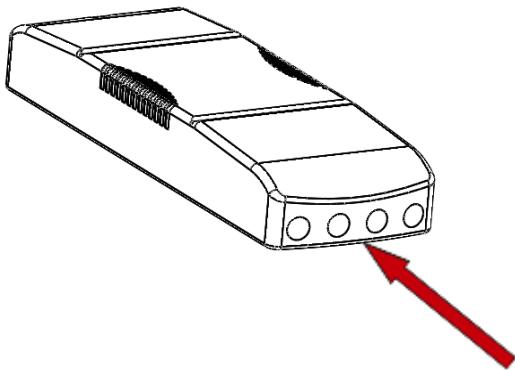

4.

Pass the gear box back up through the cutout and position in the ceiling void behind.

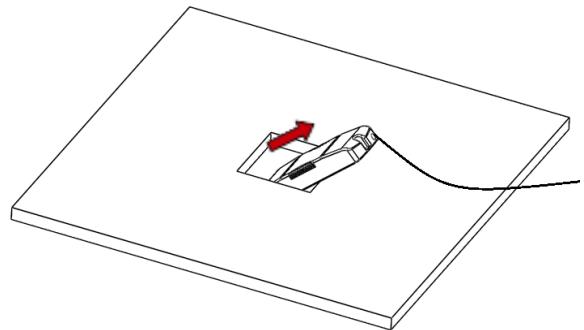

5.

Offer the single pod up to the cutout. Force the springs back on themselves and position the fitting into the cutout.

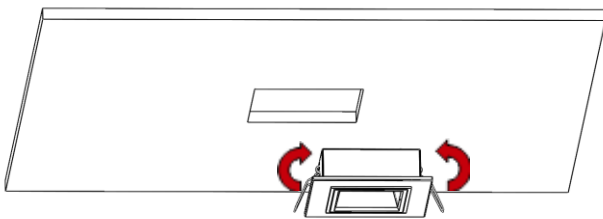

6.

The springs will engage pulling the fitting up flush against the front face of the ceiling.

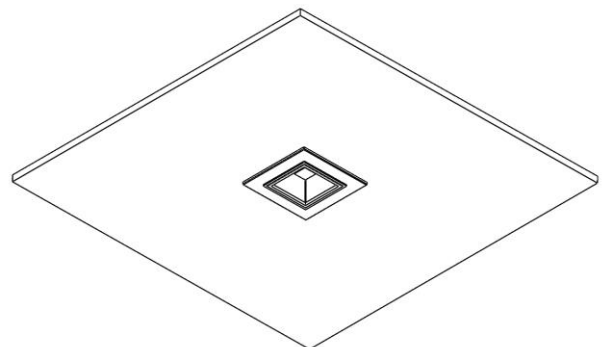

Rubix 1 Installation

Maintenance

- ① Disconnect luminaire before undertaking any maintenance or cleaning.
- ② Cleaning should be undertaken on external parts of the luminaire only using a slightly damp lint free cloth.
- ③ Head contains non-serviceable parts, replace driver only.
- ④ Please contact Dextra for assistance with spare component supply.

